

Season Plan for 8 to 9-Year-Olds

At this age, kids will begin to explore tactics and skills that help them keep possession of the ball, move downfield and score, and play good defense. The following grid provides an overview of each component of practice from Week 1 through Week 12. We based the plans on two practices per week for the first two weeks, and then one practice per week once the regular season starts.

Overview of the Season Plan

The Season Plan on the next page provides a weekly guide and addresses tactical and skill components, and other activities fully detailed in the Practice Plans document. The Season Plan has five components:

- **Purpose:** The purpose of the practice is your main focus.
- **Tactics and Skills:** Tactics are knowing what to do during the game (and when to do it), and they require an understanding of the problems faced by each team during the game and how those problems can be solved. Ways to maintain possession of the ball would be tactics. Skills are the physical skills traditionally taught, such as controlling the ball during play.
- **Rules and Traditions:** You will teach the rules of the sport to young children gradually, as part of playing games and learning skills. Traditions are those unwritten rules that players follow to be courteous and safe, such as raising your hand when you foul someone or playing cooperatively with the others on your team.
- **Fitness Concepts:** Even young children can understand some simple concepts about health and fitness, such as the idea that exercise strengthens your heart, so some of these are suggested as the focus for brief discussions during practice.
- **Character Development Concepts:** The four core values—caring, honesty, respect, and responsibility—can all be related to many situations arising while playing flag football. For example, playing cooperatively with teammates shows that you care about them. Again, we'll suggest some specific ideas for briefly discussing character development values.

“YMCA Youth Flag Football Rules” do not include punting, kicking, and contact blocking. Please disregard references to these activities throughout this Season Plan.

YMCA Winners Flag Football Season Plan

8- to 9-Year-Olds

Week	Purpose	Tactics and skills	Rules and traditions	Fitness concepts	Character development concepts
1A	To learn basic offensive skills	Passing, catching	Passing rules	General fitness Your heart is a muscle that pumps your blood.	Four core values Incorporate the four core values.
1B	To learn two pass patterns	Square-out, slants; punting, punt receiving and coverage	Receiving rules	General fitness Your breathing rate increases as you exercise.	Honesty Be honest about violations.
2A	To learn two blocks	Pass blocks, open-the-hole blocks	Blocking rules	Cardiorespiratory health and fitness The best exercises for your heart are the ones that get your entire body moving.	Responsibility Be responsible to your teammates.
2B	To set up the offensive attack	Offensive numbering system, one pass play, one running play	Rules for starting a play	Muscular fitness Muscle endurance is how many times you can exercise your muscles.	Respect Respect your opponents.
3	To play effective defense	2-3-1 defense, flag pulling	Flag-guarding and flag-pulling rules	Muscular fitness Flexibility is your ability to move your joints through their full range of motion.	Responsibility Be supportive of your teammates.
4	To learn a new pass pattern	Curls, placekicking	Dead-ball rule	Body type Fat is important—it gives you energy and protects your body.	Caring Encourage your teammates.
5	To strengthen the offensive attack	Two new pass plays	Shovel pass rule	Body type Regardless of your body type, do a variety of activities that will help you be fit.	Caring Share the ball with your teammates.
6	To play effective defense	Covering receivers	Pass interference rule	Training and conditioning People improve their fitness levels at different rates.	Respect Celebrate wins while respecting your opponents.

(continued)

“YMCA Youth Flag Football Rules” do not include punting, kicking, and contact blocking. Please disregard references to these activities throughout this Season Plan.

YMCA Winners Flag Football Season Plan

8- to 9-Year-Olds (continued)

Week	Purpose	Tactics and skills	Rules and traditions	Fitness concepts	Character development concepts
7	To learn a new pass pattern	Streaks	Player-in-motion rule	Traffic safety Be careful when exercising on sidewalks, paths, and near roads.	Respect Respect officials.
8	To strengthen the offensive attack	Two new running plays	Line of scrimmage, clipping, and illegal use of hands rules	Healthy habits Try to avoid soda—it does nothing to help you build a healthy body.	Responsibility Work together as a team.
9	To play effective defense	Defensive line play; rushing the passer	Defensive holding rule	Healthy habits Try to choose meals from the bottom of the food pyramid.	Caring Involve your teammates in the action.
10	To strengthen the offensive attack	Returning punts	Unnecessary roughness rule	Healthy habits Cigarette smoking causes more disease than any other single thing.	Caring Forgive teammates for mistakes.
11	To play effective defense	Defending against punt returns	Fair catch interference rule	Flexibility Stretch until you feel a pull but no pain; hold for 10 seconds.	Responsibility Work hard to improve.
12	To strengthen the offensive attack	Review passing and running plays	Handoff rules	Safety It's important to notify your coach whenever you hurt yourself, even if you think it's a minor injury.	Respect Respect yourself and your teammates.

Practice Plans for 8- to 9- Year-Olds

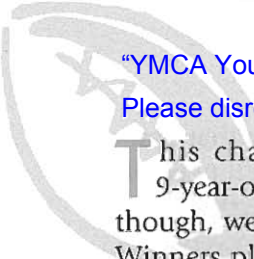
“YMCA Youth Flag Football Rules” do not include punting, kicking, and contact blocking. Please disregard references to these activities throughout this Season Plan.

This chapter contains 14 practice plans to use with your 8- and 9-year-old YMCA Winners flag football players. Before we get to those plans, though, we’ll explain the modifications to the game that are used in YMCA Winners play and give you a quick overview of what’s in the practice plans and how they are to be used.



Game Modifications

YMCA Winners play 6 v 6 games. This speeds up the game and gives kids more opportunities to be involved in the play. Have no more than 12 players on a team. The field is also smaller than regulation: we recommend a 40-yard by 80-yard field. Another modification is in the ball itself: we recommend using a youth-size ball (10 1/4 to 10 1/2 inches).

Many of the rules for flag football have been adapted to make them more appropriate for the age and skill levels of 8- and 9-year-olds. For example, at this level, kickoffs do not take place; punts and running plays are allowed (in YMCA Rookies they aren’t); and all offensive players are eligible to receive forward passes. See chapter 14 for more on flag football rules. (We do introduce the skill of kicking off, because kicking is a part of the skills test for this level, but it is not used in games until later.)

We highly recommend you have at least one assistant coach to help you watch and instruct the players.

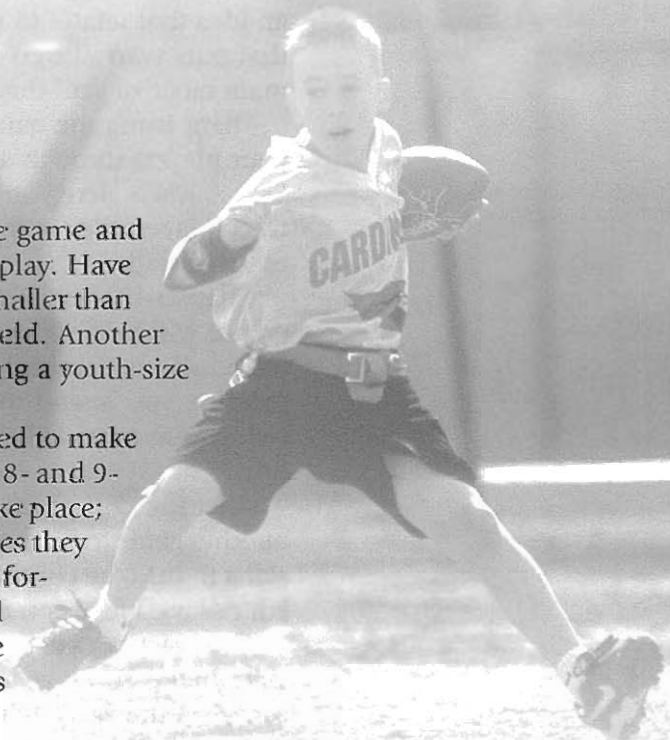

Encourage parents to help you—the more assistants you have, the more attention each player can get.



Practice Plan Organization

Each plan contains the following sections:

- ⊙ Purpose
- ⊙ Equipment
- ⊙ Warm-Up
- ⊙ Fitness Circle
- ⊙ Game 1
- ⊙ Skill Practice(s)
- ⊙ Game 2
- ⊙ Team Circle

Purpose focuses on what you want to teach your players during that practice; it is your main theme for that day. *Equipment* notes what you'll need on hand for that practice (and the size of the field). The *Warm-Up* section gives you 10 minutes of warm-up activities. This segment will be followed by 5 minutes of the *Fitness Circle*, during which you briefly talk with players about an idea that relates to health or fitness. Then, in *Game 1*, you'll play a game that puts your players in a game-like situation and introduces them to the main tactic or skill that you want them to learn that day.

Then, using the games approach as described in chapter 8, you'll guide your players through a short question-and-answer session that leads to the *Skill Practice*. Here you will have one or two skill practices in which you will teach players the tactic or skill and then conduct a fun drill for them to practice that skill.

Chapter 13 contains descriptions of all the tactics and skills, so a page reference will be given to guide you to the appropriate description there. The introduction, demonstration, and explanation should be brief. As the players practice, you attend to individual players, guiding them with *Coach's Cues* (which are provided throughout the practice plans) or further demonstration.

After the skill practices, you will go on to *Game 2* and have the kids play another game to let them use the skills they just learned and to see how those skills fit into the context of a game. We provide *Coach's Points* for you to help your players focus on the most important points.















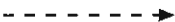





The practice concludes with a *Team Circle*, which focuses on character development. You take about 5 minutes to talk with your players about some aspect of the game that relates to one of the four core values—caring, hon-

esty, respect, or responsibility. Following this, you wrap up the practice with a reminder of the next practice or game day and time and a preview of what you will teach in that next practice.

A note about Fitness and Team Circles: these times are meant to be true discussions, not lectures where you do all the talking and the kids do all the listening. Ask the questions provided and wait for your players to respond. Don't feed them the answers that we provide; these answers are only meant to help you guide the discussion. The kids' wording of answers doesn't have to match what we give here; that wording is presented for your benefit, so you know where to guide them. Your role in team circles is as much to ask questions and get players to respond as it is to dole out information.

The plans in this chapter, combined with the information in the rest of this book, should give you everything you need to lead practices. Just remember to be patient and caring as you work on skills. Kids progress at different rates, and it's more important that they learn the sport in a positive way than it is that they learn quickly.

Key to Diagrams

Player movement without ball		Defensive line player.....	
Player movement with ball.....		Linebacker	
Pass, snap, punt, or kick		Defensive back.....	
Block		Punter	
Sequence of movement	1,2,3	Punt returner.....	
Simultaneous sequence of movement	1-,2-,3-	Kicker	
Cone.....		Kickoff returner	
Quarterback.....		Blocker	
Center (snapper)		Defender	
Running back.....		Teammate	
Receiver.....		Kicking tee	T
		Ball	

Week 1, Practice 1

PURPOSE

To learn basic offensive skills.

Equipment

- One football for every two players (youth-size: 10 1/4 to 10 1/2 in.)
- Flag belts for all players
- Grass field 40 yards by 80 yards

Warm-Up (10 minutes)

Begin each practice with 10 minutes of warm-up activities to get players loosened up and ready to go.

Have players jog one lap around the field and then lead them in jumping jacks and stretches for the arms and legs.

Fitness Circle

(5 minutes)

Following the Warm-Up, gather the players and briefly discuss the fitness concept for that practice.

Key Idea: General fitness

Materials: One paper towel tube for every two players.

Gather the players together. "Your heart is a pump. It is a strong pump. It pumps 5,000 to 6,000 quarts of blood each day around your body. If you drink a quart of milk a day, it will take you more than 15 years to drink 5,000 quarts of milk, yet your heart pumps all that in one day. Your heart pumps 80 to 100 times a minute. That means your heart is beating 5,000 times every hour, 120,000 times a day, and 54 million times each year. As you get older, your heartbeat slows down a little, so by the time you are in the 12th grade, it will beat only 70 to 80 times a minute, or slower. Your heart is a muscular pump. It's about the size of your clenched fist and weighs about six to nine ounces. That's about the weight of a softball.

"Your heart is located in the front of your chest behind your breastbone. If you put your hand on your chest and a little to the left of the breastbone, you might be able to feel your heart pumping."

Activity: Listening to your heartbeat

Put the children in groups of two. Give each pair a paper towel tube. Have one child place an open end of the tube against the middle of the back of his or her partner. Ask the children if they can hear their partners' hearts beating. Ask them what the heart sounds like, or what sound it makes.

[Sounds like thumping or goes lub-dub.]

Switch roles.

Week 1, Practice 1

Game 1 (15 minutes)

Following the Fitness Circle, get the kids playing a game. Then interrupt each game with a time of questions and answers, with you asking the questions and your players providing the answers (about what the goal of the game was and what skills and tactics they needed to perform to succeed in the game). For many games, we provide diagrams or figures showing how the game is played. We also often provide coaching points for you to pass along to your players during the games.

Goal

To move downfield and score.

Description

Assign three players to a team. Each team is on offense; there is no defense. The offenses start at midfield and have six passes to try to score a touchdown. The ball is downed where it is caught. After each play, offensive players shift to a new position so that each player gets to pass. For each pass caught the team gets one point. If the players on a team catch all six passes, the team gets two bonus points—and they get six points if they score a touchdown.

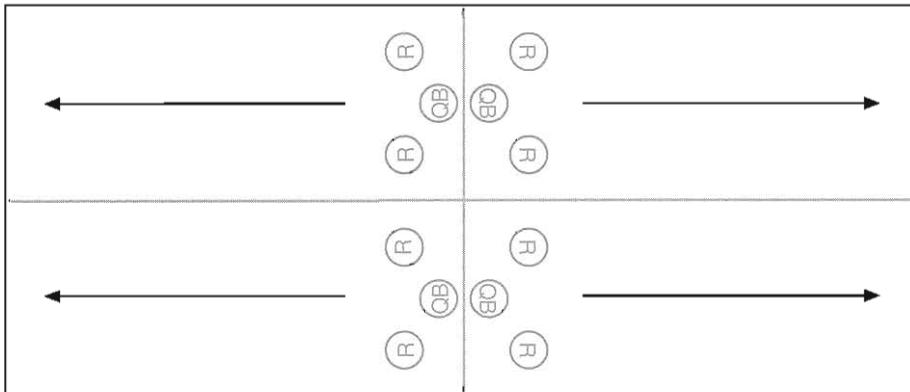

Coach: What's the goal of this game?

Players: To move down the field and score.

Coach: How do you do that?

Players: Throw the ball so the receivers can catch it.

Coach: And how do you do that?

Players: Use the right grip and arm motion.



Week 1, Practice 1 (cont'd)

- You'll follow game 1 with one or more skill practices, during which you'll
- introduce, demonstrate, and explain a skill or tactic, and then attend to your
- players as they practice it. The question-and-answer session, in which your
- players tell you what skills and tactics they need to be successful in the game,
- leads directly to the skill practice. We often provide coaching points with the
- skill practices; pass these points along to your players. We also provide coach's
- cues—phrases to help your players focus on the task at hand—in many skill
- practices and games.

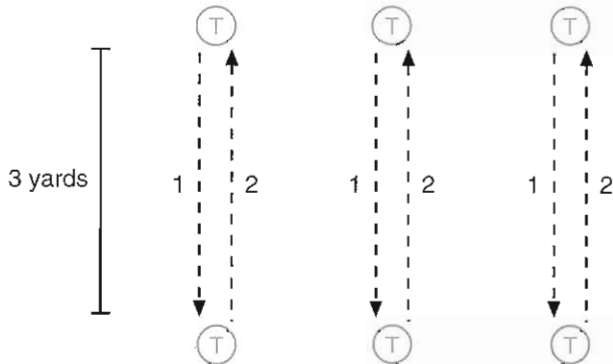

Skill Practice 1 (15 minutes)

1. Introduce, demonstrate, and explain how to throw the football (see page 262).
2. Have players practice throwing.

Description

Players in pairs play catch, standing about 3 yards apart. Have them hold the ball high for good rotation and release.

COACH'S cues



- "Spread your fingers on the ball."
- "Hold the ball behind your ear."
- "Keep your body facing the receiver."
- "Snap your wrist!"

Skill Practice 2 (10 minutes)

Description

Review how to properly catch the football. Continue with the same pairs as in Skill Practice 1, and have the players in each pair alternate being the quarterback and the receiver. Receivers go out for short passes, running whatever routes they want.

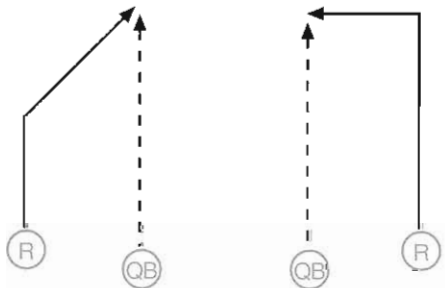

Game 2 (15 minutes)

Goal

- To pass downfield and score.

Description

- Assign three players to a team. Each team starts at midfield, in a
- separate quadrant of the field. The quarterbacks pass to their receivers;

Week 1, Practice 1

the balls are downed where caught. Teams move downfield and score, then return to midfield to repeat the action. After each play, players rotate within their own teams so that everyone gets a chance to play quarterback. The team scoring the most touchdowns wins.

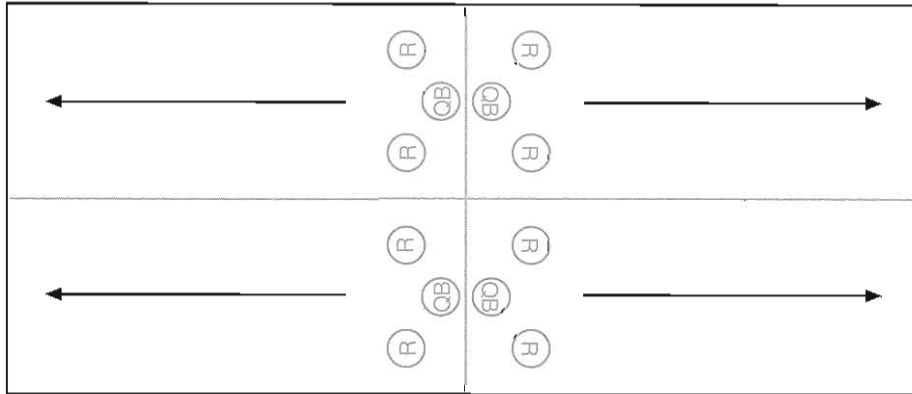

COACH'S
points

- ☞ Reinforce correct throwing mechanics while running games and drills.
- ☞ Go over passing rules (see page 282).

Team Circle (5 minutes)

Conclude practice by gathering your players and discussing a character development concept. These aren't lectures; you want your players' active participation in these discussions. Following the discussions, wrap up the practice with a few comments.

Key Idea: *The four core values*

Gather the team into a circle. Ask one player with a strong leg to kick a ball. Ask another with a strong arm to throw a pass to a receiver.

"Kicking, passing, and catching are three skills that you need to succeed in this game. We're going to work on those skills all season. But we all need four qualities that will help us, too: respect, honesty, responsibility, and caring. These qualities are just as important as kicking and passing and catching. Give me an example of each of the four values." Listen to their responses and discuss.

Wrap-Up

Make summary comments about practice. Remind players of the next practice and give them a sneak preview of its emphasis—learning pass patterns.



Week 1, Practice 2

PURPOSE

To learn two pass patterns.

Equipment

- One football for every two players (youth-size: 10 1/4 to 10 1/2 in.)
- Flag belts for all players
- Grass field 40 yards by 80 yards

Warm-Up (10 minutes)

Have players run for a few minutes and then do jumping jacks and stretches.

Fitness Circle (5 minutes)

Key Idea: General fitness

Gather the players together. "When you run and play sports, your heart beats faster. Your breathing rate (respiration rate) increases. So does the depth of your breathing.

"You breathe deeper and faster to get more oxygen in your lungs. Your heart beats faster so more blood, containing oxygen, can get around your body. When sitting, your breathing rate may be 12 to 20 breaths per minute. When you run, your rate can double or even triple.

"While most of us can't control our heart rates, we can control our breathing rate to a point. I can hold my breath or breathe faster. Breathing is somewhat under my control, but not completely."

Activity: Breath holding

"Let's try to see how long we can hold our breath. Take a deep breath and hold it." (Count to see who can go the longest without breathing. Some children will try to cheat by sneaking a breath through their nose. Watch for their chests to move.)

Game 1 (10 minutes)

Goal

Receivers will run routes and get open to receive passes.

Description

Split the players into four teams, two Team As and two Team Bs, on two different parts of the field. Team As begin and remain on offense for the first half of the game; Team Bs are on offense for the second half of the game. The two Team As begin at midfield and move toward opposite goals. Receivers are to run however they want in attempting to get open and receive a pass. Defenders can play player-to-player or zone. Rotate offensive players to different positions after each play. You can opt to have each play downed where the ball is caught, or to have the defenders pull the ball carrier's flag. Award one point for each pass caught.

Week 1, Practice 2

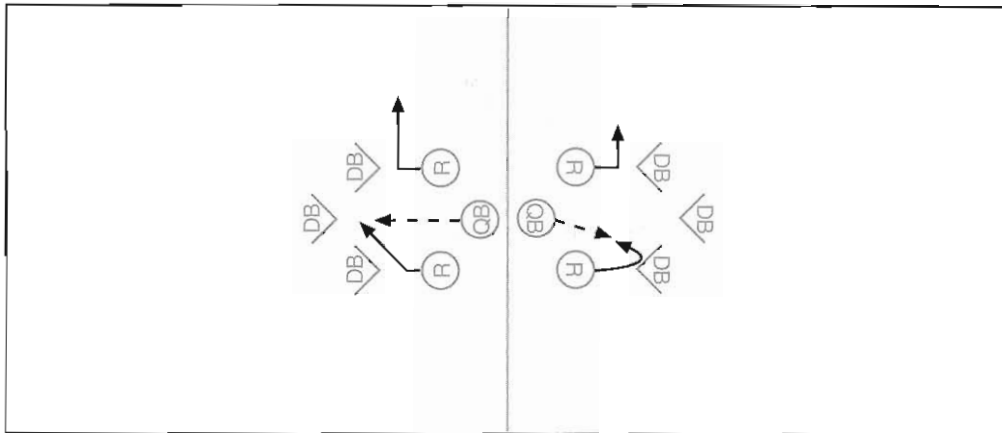

Coach: What were the receivers trying to do?

Players: Get open to catch passes.

Coach: How do you get open?

Players: By running to where the defender isn't, using different routes.

Coach: That's right. Let's learn two of those routes: square-outs and slants.



Skill Practice 1 (15 minutes)

1. Introduce, demonstrate, and explain how to catch the football on the run, using the square-out pass pattern and the slant pass pattern (see page 249). First demonstrate the square-out, then the slant.
2. Have players practice catching the football using these patterns.

Description

Pair players up and have them take turns running square-outs and slants. The receiver runs three square-outs, then switches places with the quarterback, who runs three square-outs. Repeat the process for the slants and keep switching back and forth in this manner.

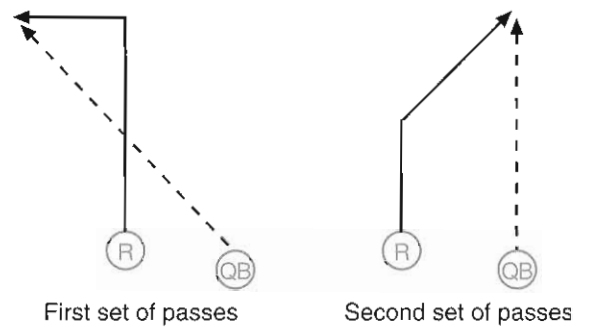

COACH'S cues



"Remember to be soft all over and catch the ball with your hands."

"Sharp cuts!"

Week 1, Practice 2 (cont'd)



Skill Practice 2 (10 minutes)

1. Introduce, demonstrate, and explain how to punt (see page 264).
2. Have players practice punting.

Description

Divide players into pairs. Have each player practice punting to his or her partner. (Player A punts; Player B receives the punt and then punts back to Player A.)



“Contact the ball’s center!”
“Follow through!”

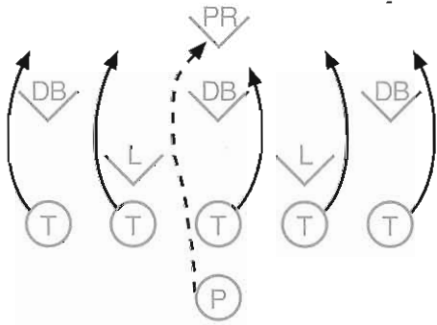

Skill Practice 3 (10 minutes)

1. Introduce, demonstrate, and explain how to properly cover punts (see page 266).
2. Practice punt coverage.

Description

Have Team A punt three times to Team B, then Team B punts three times to Team A. Each team fills their lanes and attempts to down the punt returner while allowing as few yards as possible.



“Cover your lane!”
“Ends, don’t let the ball carrier get past you on the outside!”

Week 1, Practice 2

Game 2 (10 minutes)

Goal

For each team to gain the best field advantage it can through passing and punting.

Description

Play two 3 v 3 games. The offense starts on its own goal line and has four plays—three passes and a punt—to advance as far as possible down the field. On the fourth play, they punt, no matter where they are (the defense places one player back to receive the punt). You decide whether players are down where they catch the ball or whether the defense has to pull flags. Receivers run square-outs and slants. Defenders can play player-to-player or zone. Once the punt play is finished, the team that just received the ball starts on its own goal line. Whichever team is in best field position after receiving the punts wins.

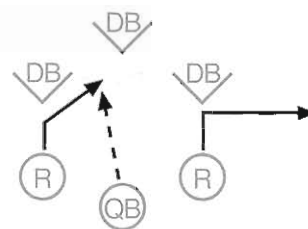

COACH'S
points

☞ Reinforce that players should always look the ball into their hands.

☞ Go over receiving rules (see page 283).

Team Circle (5 minutes)

Key Idea: Honesty

Gather the team into a group. "Think about the rules in flag football. I'm going to tell you a rule. Raise your hand if you think it's something you should let the official know happened." (Examples: pass interference, offsides, illegal use of hands.) "You should let the official know when rules are broken, even if the official doesn't see it. Raising a hand or telling officials is an honest thing to do when you break a rule, even if it's an accident. It's important to be honest when you break a rule in practices or in games. This will make you a better player and a better person."

Wrap-Up

Make summary comments about practice.
Remind players of the next practice, and give them a sneak preview—
learning two ways to block.



Week 2, Practice 1

PURPOSE

To learn two blocks.

Equipment

- One football for every two players (youth-size: 10 1/4 to 10 1/2 in.)
- Flag belts for all players
- Grass field 40 yards by 80 yards
- Seven towels or cones

Warm-Up (10 minutes)

Have the players jog one lap around the field and pair up to pass to each other, with receivers running square-outs and slants. Assign two players to practice punting after they jog around the field.

Fitness Circle (5 minutes)

Key Idea: Cardiorespiratory health and fitness

Gather the players together. "The best exercises to get your heart healthy and fit are those that get your entire body (or most of it) moving. Some of these types of exercises are basketball, bicycling, dancing, Hackey Sacking, hiking, pogo sticking, rope jumping, running, skating, swimming, and tag.

"These types of exercises force you to use the bigger muscles of your body, especially your legs. In addition, these exercises get your heart to beat faster and your breathing rate to increase. Even your depth of breathing increases. These are called *cardiorespiratory endurance* or *aerobic* exercises.

"Football is an activity that gets your whole body moving, but you have rest periods between plays."

Activity: Nonstop activities

"Which of the following are nonstop activities? That means the game or sport keeps you moving all the time."

1. Softball
2. Basketball
3. Football
4. Weightlifting
5. Running
6. Bicycling
7. Swimming
8. Pogo sticking
9. Inline skating

Week 2, Practice 1

Game 1 (10 minutes)

Goal

To block pass rushers and allow the quarterback to complete passes.

Description

Play 6 v 6. Instruct two or three defensive line players to rush the quarterback (while adhering to the 5-second rule) and attempt to pull his or her flag. Offensive receivers can run slants and square-outs. Start Team A on offense, on its own 20-yard line; give Team A six plays to advance as far as possible. Then switch offense and defense, and begin Team B on its own 20-yard line. Give Team B six plays. Whoever advances farthest wins.

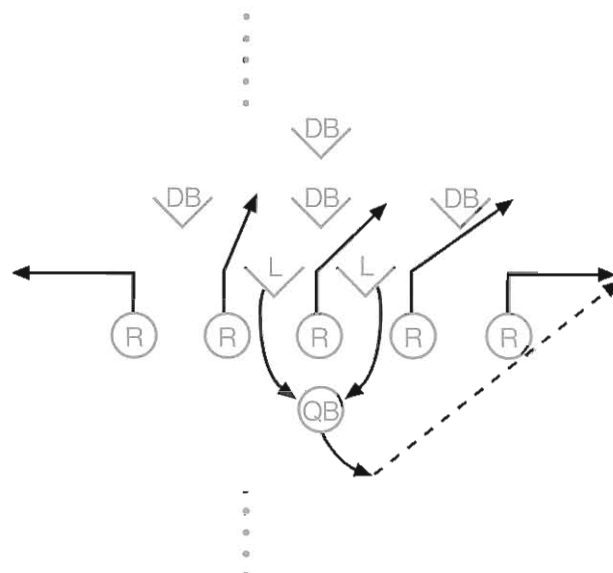

Coach: What were you trying to do in this game?

Players: Advance downfield and score.

Coach: Was the quarterback under pressure to get passes off?

Players: Yes.

Coach: How can we relieve that pressure on the quarterback and allow time to find a receiver?

Players: By blocking.



Skill Practice 1 (15 minutes)

1. Introduce, demonstrate, and explain how to pass block (see page 258).
2. Practice pass blocking.

Description

Divide the players into two groups, offense and defense. Set seven towels or cones down in a line, each one 3 yards apart from the one next to it. Six defensive players are lined up on one side of the cones, in the spaces between the cones. They are opposite six offensive players. On your command, the defensive players will rush through their lane and the offensive players will attempt to pass-block them. Defenders should not go at full strength. Switch offense and defense after three plays.

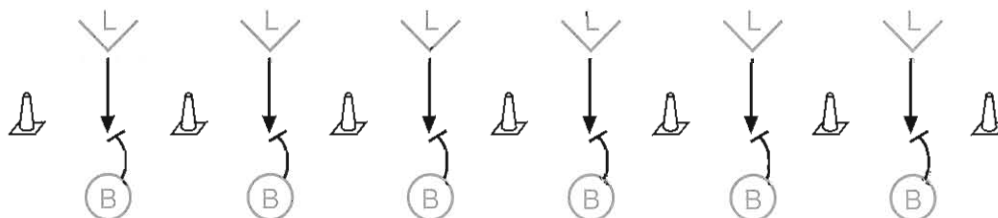

Week 2, Practice 1 (cont'd)

COACH'S cues



"Hit and retreat!"

"Block between waist and shoulders!"

Skill Practice 2 (15 minutes)

1. Introduce, demonstrate, and explain how to execute an open-the-hole block (see page 259).
2. Practice open-the-hole blocking.

Description

Repeat skill practice 1 with the blockers executing open-the-hole blocking. Before each play instruct blockers which way to "open the hole": block left means players should move defenders to the offensive player's left; block right means defenders should be blocked to the right.

COACH'S cues



"Block between waist and shoulders!"

"Drive the legs!"

Game 2 (15 minutes)

Goal

To block pass rushers and allow the quarterback to complete passes.

Description

Play 6 v 6. Defenders can play player-to-player or zone. Give two points to the offense every time the quarterback gets a pass off without being pressured, and add a point for every completion. A touchdown counts two points. Play a regular game, complete with punting.

COACH'S points

It's not size, but technique, that makes a good blocker.

Go over blocking rules (see page 258).

Week 2, Practice 1

Team Circle (5 minutes)

Key Idea: Responsibility

Pair off the players. "Everyone stand and balance on one foot." Wait while the players get their balance. Then have them stand on two feet again. "Now one of you offer your shoulder for your teammate to lean on. If you're leaning on your partner's shoulder, now try to balance on one foot again. Change places. If you were leaning before, now let your partner lean on your shoulder and stand on one foot." Wait until everyone has balanced with the help of a partner. "Wasn't it easier to balance when you were leaning on your partner? It works that way in flag football, too. When you help each other during practices and games, we work better as a team; each of you can contribute. Your teammates count on you to contribute to the team. That is being responsible to your team."

Wrap-Up

Make summary comments about practice. Remind players of the next practice and give them a sneak preview—learning a pass play and a running play.



Week 2, Practice 2

PURPOSE

To set up the offensive attack.

Equipment

- One football for every two players (youth-size: 10 1/4 to 10 1/2 in.)
- Flag belts for all players
- Grass field 40 yards by 80 yards
- Clipboard and paper

Warm-Up (10 minutes)

Have players jog one lap around the field and then pair up to pass back and forth to each other, running square-outs and slants. Assign two players to practice punting after they jog around the field.

Fitness Circle (5 minutes)

Key Idea: Muscular fitness

Equipment: Horizontal bar

Gather the players together. "You probably have heard stories of people who showed superhuman strength. For example, a mother who lifted a heavy limb of a tree that fell on her child. Then after the child escaped, the mother was unable to do it again.

"The words *muscle strength* mean the maximum amount of weight you can lift, such as the mother lifting the log off her child. Trying to see the most pounds you can lift over your head is a muscle strength exercise. Muscle endurance refers to how many times you can exercise your muscles. How many times you can lift a certain weight over your head is an example of muscle endurance. Muscle power is muscle strength combined with how fast you can move a muscle. A long jump or high jump are examples of muscle power. Football players usually have lots of muscle power."

Activity: Strength, endurance, power

"Try one of the strength exercises described on page 294: push-ups, bench crunches, or standing long jumps."

Week 2, Practice 2

Game 1 (10 minutes)

Goal

To use pass routes to get open and advance downfield and score.

Description

Play 6 v 6. The offense starts at its own 20-yard line and uses pass plays only to try to advance downfield. Give each team six plays to see how far it can advance. The team that advances the farthest wins. No plays are called; the receivers just choose to run routes that they know: square-outs and slants. Defenders can play player-to-player or zone. The defense can rush the quarterback with any number of rushers.

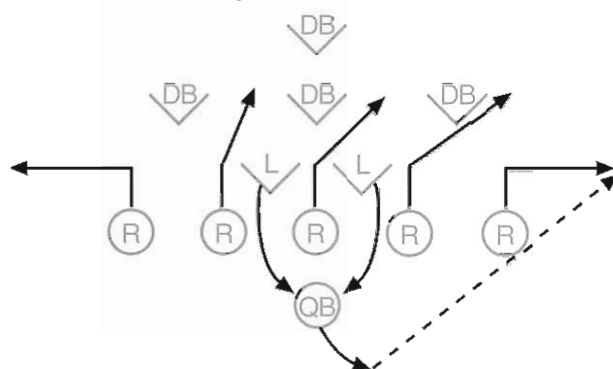

Coach: What was the object of the game?

Players: To move downfield and score.

Coach: Was it confusing for the quarterback, not knowing where his [or her] receivers were going?

Players: Yes.

Coach: How can we make the offense run smoother and help the quarterback out?

Players: By running set plays.



Skill Practice 1 (20 minutes)

1. Introduce, demonstrate, and explain the offensive numbering system and how to run pass play #1—end square-outs (see pages 248 and 249).
2. Practice pass play #1.

Description

Explain the numbered holes on the line of scrimmage and numbers for players (see page 248). Have the numbered holes and players drawn on a large clipboard prior to the practice.

Divide players into two teams of six; both teams are on offense and practice on separate halves of the field. Set the players up in the correct positions and have them run the pass play #1 several times. Have players rotate positions after several plays so that they can experience the play from different positions.

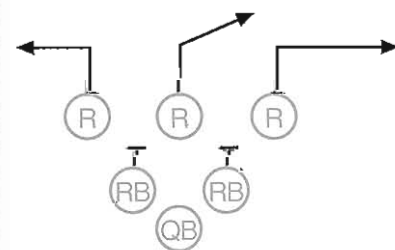

Week 2, Practice 2 (cont'd)

Skill Practice 2 (15 minutes)

1. Introduce, demonstrate, and explain how to execute run play #1—34 sweep (see page 250).
2. Practice run play #1.

Description

Run two offenses of six players each on separate halves of the field. Set the players up in the correct positions and have them execute run play #1 several times. Have players rotate positions after several plays so that they can experience the play from different positions.

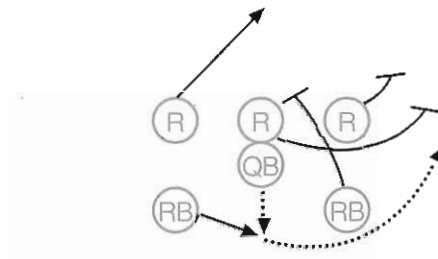

Game 2 (10 minutes)

Goal

To advance down the field using a running play and a passing play.

Description

Play 6 v 6. Team A starts on its own 20-yard line and has six plays to advance as far as possible. Defenders can play player-to-player or zone. Then Team B goes on offense and does likewise. Each team runs the two plays just learned; the quarterbacks call the plays in the huddle. The team that advances farther wins.

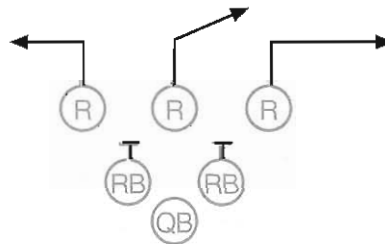

☞ Each player needs to focus on his or her responsibility for each play.

☞ Go over rules for starting a play (see page 281).

☞ Designate a punter or two and have them practice punting each practice, either during warm-ups or at some other time.

Week 2, Practice 2

Team Circle (5 minutes)

Key Idea: Respect

Divide the team into two lines. "I want each line to walk toward the other and give each person in the other line a high-five. Imagine that the other line is your opponent for a game. Show me how you would act toward an opponent and what you would say if it was the end of the game and we lost the game. Start." Listen to players' comments to each other. "At the end of each game it is important to show respect for your opponent. We do this by slapping hands and saying something like 'good game,' even if we lose the game."

Wrap-Up

Make summary comments about practice. Remind players of the next practice and give them a sneak preview—learning the 2-3-1 defense.



Week 3

PURPOSE

To play effective defense.

Equipment

- One football for every two players (youth-size: 10 1/4 to 10 1/2 in.)
- Flag belts for all players
- Grass field 40 yards by 80 yards
- 8 cones

Warm-Up (10 minutes)

- Have players jog one lap around the field and then pair up to throw passes to each other, running the pass patterns they have learned.
- Assign two players to practice punting after they jog around the field.

Fitness Circle (5 minutes)

Key Idea: Muscular fitness

Gather the players together. "Flexibility is the ability to move your joints through their full range of motion. Here's a game that tests your flexibility."

Activity: Knots

"Get into two groups of six people. Follow these important rules: You are to shake hands with two different people. Your left hand is to shake the left hand of one partner and your right hand is to shake the right hand of another partner. You cannot shake hands with the person to your immediate right or immediate left. And you are not to shake both hands with the same person." (When the children understand these rules, they are to get into a cluster and try to follow them. Once they have the idea, tell them that the goal is to form a large circle without letting go of the hands of their partners. This works nine out of ten times. On occasion, two or even three circles are formed. Some children will get stuck. The object is to step under, over, crawl under, etc., as they try to make a circle. As they are doing this, emphasize teamwork and the fact that this is working on flexibility.)

Game 1 (15 minutes)

Goal

To prevent first downs by pulling the ball carrier's flag.

Description

Play 6 v 6. Team A starts on offense on its own 20-yard line. It continues on offense until it is stopped from making a first down or it scores; at this point Team B takes over on offense and begins from its own 20-yard line (regardless of where the ball was stopped). Defenders can play player-to-player or zone. Give one point to the defense for pulling a flag

Week 3

before a first down is made, and three points to the offense for each first down made. A touchdown is worth six points.

Coach: What was the object of the game?

Players: To stop offensive progress by pulling the flag.

Coach: How do you pull the flag?

Players: Keep your balance, don't lunge at the ball carrier, slide to the side to avoid contact.



Skill Practice 1 (15 minutes)

1. Introduce, demonstrate, and explain how to pull flags in these situations: head on, angle, and open field (see page 270).
2. Practice pulling flags.

Description

Mark two zones with cones; each zone should be 3 yards wide by 3 yards long. Assign six players to each zone—three on offense, three on defense. An offensive ball carrier and a defender go on-on-one in each zone; the ball carrier attempts to elude the defender, who attempts to pull his or her flag.



"Keep a low center of gravity."

"Wait for the offensive player to come to you."

"Keep your eye on the target and have soft hands."

"Use the wraparound method."

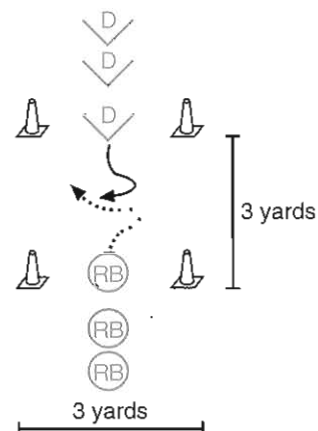

Skill Practice 2 (15 minutes)

1. Introduce, demonstrate, and explain the 2-3-1 defense (see page 252).
2. Practice the 2-3-1 defense.

Description

Play 6 v 6. Call out the play for the offense, alternating between pass play #1 and run play #1. If possible, have an assistant coach the two defensive line players while you coach the linebackers and defensive back. After each play is run, go over the responsibilities of each defender for that play. Switch teams halfway through so that all players get to play on defense.

Game 2 (10 minutes)

Goal

To prevent first downs by pulling the ball carrier's flag.

Description

Repeat game 1, playing a 2-3-1 defense.

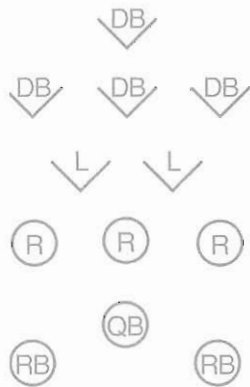

☞ Encourage players to pursue the runner until they pull the flag or force the runner out of bounds.

☞ Go over flag-guarding and flag-pulling rules (see page 285).



Team Circle (5 minutes)

Key Idea: Responsibility

Divide the team into two groups. Have one group spread out and pass to each other. Place the other group to one side, as if on the sidelines during a game; direct them to be silent for the first 30 seconds of the activity. After 30 seconds, have them cheer and encourage their teammates. Continue this activity for 30 more seconds. "When players are on the sidelines during a game, they should be encouraging their teammates, no matter what's happening in the game. This is being responsible to your team. It helps players keep trying hard even if they are losing or have made some mistakes. How did it feel when you were playing and the sideline players didn't encourage you? How about when they did encourage you?" Listen to both responses and help players compare feelings.

Wrap-Up

Make summary comments about practice, and remind players of the next game.

Week 4

Warm-Up (10 minutes)

Have players jog one lap around the field and then do 10 jumping jacks and 10 push-ups. Then have players pair up and play catch with each other, running pass patterns they have learned. Assign two players to practice punting after they jog around the field.

Fitness Circle (5 minutes)

Key Idea: Body type

Gather the players together. "Fat is important. We need some on our bodies. See if you can find fat on your body. (I sure hope so!) Take your arm and hold it out straight. Now try to grasp (actually, pinch) the back of your extended arm. Don't dig in too deep, just try to get your skin and the tissue right below your skin. Did you find some?"

"The back of your arm is not the only place you have fat. It is almost everywhere on your body. You need this fat. It is used for energy. If you were shipwrecked with Robinson Crusoe without food, you could live off the fat stored on your body.

"Fat also protects your body. When you get blocked hard in football, when you fall or when someone runs into you, the fat acts as a cushion. Fat, because it is lighter than water, helps you float. This would be important if you and Robinson Crusoe were trying to get to the island after being shipwrecked.

"Fat keeps you warm, like insulation. It is like an 'under-the-skin' jacket or sweater."

Game 1 (15 minutes)

Goal

To advance down the field using square-outs and slants.

Description

Play two simultaneous 3 v 3 games. Instruct the right ends to run square-outs and the left ends to run slants—and double-cover the right end and instruct all defenders to overplay for the patterns that are being run. The defense knows what patterns will be run. Give one point for each reception and six points for a touchdown. Switch offenses and defenses at 5 minutes.

PURPOSE

To learn a new pass pattern.

Equipment

- One football for every two players (youth-size: 10 1/4 to 10 1/2 in.)
- Flag belts for all players
- Grass field 40 yards by 80 yards

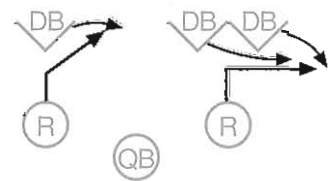



Coach: What was the goal of the game?

Players: To catch passes while running square-outs and slants.

Coach: How successful were you?

Players: Not very successful. The defenders were ready for what was coming.

Coach: How can we make it harder on the defenders?

Players: By running different patterns.

Skill Practice 1 (10 minutes)

1. Introduce, demonstrate, and explain how to run curl patterns (see page 247).
2. Practice running curl patterns.

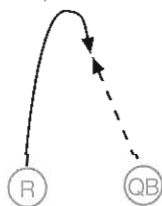

Description

Pair players up and have them take turns running curls. The receiver catches passes while running three curls, then switches places with the quarterback, who runs three curls. Keep switching back and forth in this manner.



"Drive downfield!"

"Curl back!"

"Soft hands!"

Skill Practice 2 (10 minutes)

1. Introduce, demonstrate, and explain how to kick off (see page 268).
2. Practice kicking off.

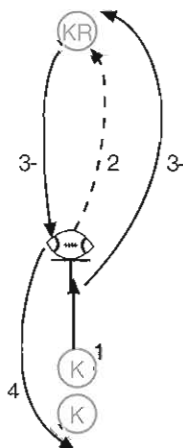

Description

Divide players into groups of three. Give each group a ball and a tee. Have two players behind each tee, and one player in each group down the field to field his or her team's kickoff. That player will return the ball to the tee and take his or her place in the kicking line. The player who kicks the ball takes the return player's place. Continue rotating in this fashion.

Week 4

Game 2 (20 minutes)

Goal

To advance downfield using three pass patterns.

Description

Play 6 v 6. Receivers run square-outs, slants, and curls. Give one point to the offense for each reception, two points for each first down, and six points for a touchdown. Play a regulation game—the offense can go for a first down on fourth down, or punt. Defenders play in a 2-3-1 alignment.

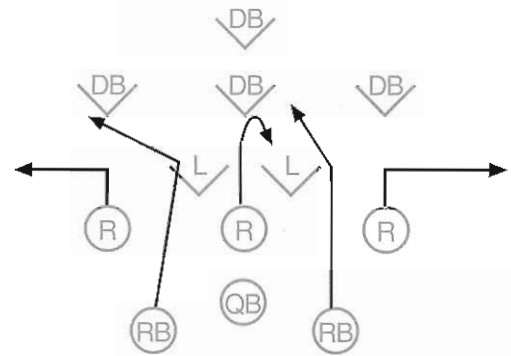

COACH'S
points

☞ Explain that kickoffs are not used in games at this level but are part of the skills test. Encourage kids to try kicking off on their own; this is the only time they will do it in practice.

☞ Be patient with players as they learn new skills and incorporate new plays.

☞ Go over the dead-ball rule (see page 283).

Team Circle (5 minutes)

Key Idea: Caring

Pair off the players and give each pair a ball; instruct them to pass the ball to each other. "Each of you should say two good things about your partner's passing and catching skills. Then come back to me in a group. Begin." Wait for them to regroup. "What were some of the comments your teammates told you?" Listen to their responses. "What kind of value or quality is it when you go out of your way to say something good about a teammate's playing?" Listen to responses and encourage discussion as needed. "Caring is one of our core values. You show you care about your teammates when you encourage them."

Wrap-Up

Make summary comments about the practice and give reminders for the next game.



Week 5

PURPOSE

To strengthen the offensive attack.

Equipment

- One football for every two players (youth-size: 10 1/4 to 10 1/2 in.)
- Flag belts for all players
- Grass field 40 yards by 80 yards

Warm-Up (10 minutes)

Have players jog one lap around the field and then have them pair up and play catch, running pass patterns. Assign two players to practice punting after they jog around the field.

Fitness Circle (5 minutes)

Key Idea: Body type

Gather the participants together. "We come in all shapes and sizes. Some of us are heavy, some thin, and some muscular. You can use your body type to your advantage for exercise. If you are thin, maybe you will like running or playing racquet sports best. If you are heavy, maybe your favorite sport is being a lineman in football or doing water aerobics. If you are muscular, almost any sport will do—wrestling, martial arts, or football, for example. If you are heavy, you probably won't like doing pull-ups, but you probably would do well pushing a car out of the mud or moving a piano. If you are really thin, swimming might make you feel uncomfortable because you don't have enough fat insulation to protect you from the cold water. Thin people tend to do well at sports such as running, tennis, or even basketball. Regardless of your body type, do a variety of physical activities that will help you be fit."

Activity: Free-time activity

"Think about the things you did yesterday after getting home from school [watched TV, did homework, played video games, played outside]. Share with a partner what you did. Now, think about the things you could have done that would have made your after-school time a lot more physically active [visited the YMCA, played sports, exercised to a video, took the dog for a walk, jumped rope]. Share with your partner what you could have done. What are your observations?"

Week 5

Game 1 (10 minutes)

Goal

To advance downfield, using pass play #1.

Description

Play 6 v 6. The defense plays in a 2-3-1 alignment. Instruct the defense to rush one player; the other five defenders cover the three receivers that go out for a pass in pass play #1 (see page 249). The offense runs pass play #1 on all plays, beginning on its own 20-yard line. The defense overplays the receivers, knowing what routes they are running. After six plays or a touchdown, whichever comes first, switch the offense and the defense and begin again on the 20. The team that scores the most—or advances the farthest, if there is no score—wins.

Coach: How difficult was it to advance downfield?

Players: Very difficult.

Coach: How can we make it easier for the offense to advance?

Players: Use more plays.

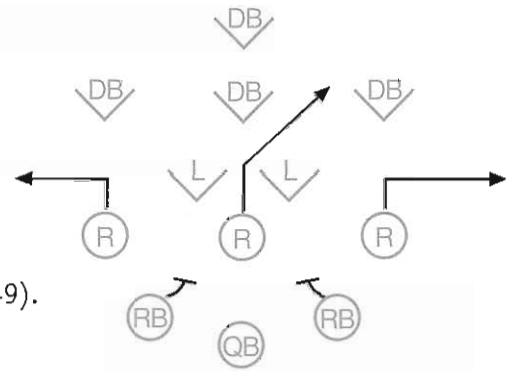

Skill Practice 1 (15 minutes)

1. Introduce, demonstrate, and explain how to run pass play #2—the quarterback bootleg (see page 249). Remind players of the numbered holes on the line of scrimmage and numbers for players.
2. Practice pass play #2.

Description

Divide players into two teams of six; both teams are on offense and practice on separate halves of the field. Set the players up in the correct positions and have them run the pass play #2 several times. Have players rotate positions after several plays so that they can experience the play from different positions.

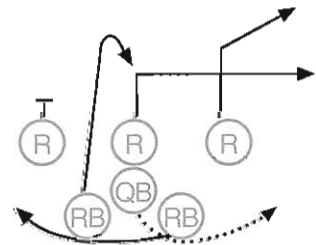

Skill Practice 2 (15 minutes)

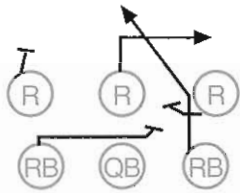

1. Introduce, demonstrate, and explain how to run pass play #3—the spread halfback slant (see page 249).
2. Practice pass play #3.

Description

Divide players into two teams of six; both teams are on offense and practice on separate halves of the field. Set the players up in the correct positions and have them run pass play #3 several times. Have players rotate positions after several plays so that they can experience the play from different positions.



“Sharp cuts!”
“Run your route!”



☞ Players enjoy learning new plays because it makes the game more fun.

☞ Go over the shovel pass rule (see page 282).

Game 2 (15 minutes)

Goal

To move downfield and score, using pass play #s 1, 2, and 3.

Description

Play 6 v 6. Team A starts on its own 20-yard line. You call the play in the huddle so only the offense can hear. The defense plays a 2-3-1 defense. Mix up the plays among the three pass plays. Give Team A five plays to advance as far as it can. Then give Team B five plays, beginning from its own 20, to advance as far as it can. Whoever gains the most yards (or scores) wins.

Week 5

Team Circle (5 minutes)

Key Idea: Caring

Gather the team into a group and choose two players to demonstrate with you. You, as the quarterback, will bootleg with the ball; the two players will go out for a pass. Tell them to shout and wave their arms if they're open (which, of course, they will be). Keep running; do not pass the ball. "Were the other players in good position to get a pass? Why didn't they get the ball? I didn't pass the ball, did I? Why didn't I? That's right—because I'm a ball hog! You can see how it makes you feel when one person keeps the ball too long. Sharing the ball so everyone gets a chance shows that you care about your teammates." Have players get into groups of three and practice the scenario they just saw—except the quarterback passes the ball. Bring players back together. "Raise your hand if you think that caring is an important quality or value on this team. Yes—it is important!"

Wrap-Up

Make summary comments about practice and give reminders about the next game.



Week 6

PURPOSE

To play effective defense.

Equipment

- One football for every two players (youth-size: 10 1/4 to 10 1/2 in.)
- Flag belts for all players
- Grass field 40 yards by 80 yards

Warm-Up (10 minutes)

Have players jog one lap around the field, do 10 push-ups and sit-ups, and pair up to pass to each other, running the patterns they have learned. Assign two players to practice punting after they jog around the field and do the push-ups and sit-ups.

Fitness Circle (5 minutes)

Key Idea: Training and conditioning

Gather the players together. "People improve their fitness levels at different rates. Some of us may get fit faster than others. They may think this difference is unfair. This is just like most things in life—some people play the piano or figure out a math problem better or quicker than others. The reasons for these differences have to do with ability, knowing how to pay attention and practicing harder than others. These differences are called 'individual rates of response.'

"Keep in mind that when you get 'into shape' or reach a certain level of fitness, you will lose that fitness if you stop exercising. You cannot keep the flexibility, muscle strength, or cardiorespiratory endurance you have gained. This is called 'retrogression'—a big word. You need to keep working at an exercise. If you exercise every other day, you will be able to improve your physical fitness level."

Activity: Individual rates of improvement continuum

"Those of you who think you seem to take a long time to get into shape, put yourself over here on the left. Those of you who think you get into shape very quickly, stand on the right.

Tell me why you put yourself on the left or right."

(After the players have shared their views, see if they want to switch their positions.

Ask them why they do.)

Game 1 (15 minutes)

Goal

To stop receivers from catching passes or advancing downfield if they do catch them.

Description

Play 6 v 6. Have the offense run pass play #s 1, 2, and 3 (they can call their own plays or you can help them, but don't let the defense know

Week 6

the plays). Instruct the defenders to play well off the receivers; use a 2-3-1 defense. Otherwise play a regulation game, including punts if necessary. Give the defense a point for each incomplete pass, and the offense a point for each complete pass.

Coach: How hard was it to stop receivers from catching passes?

Players: It was hard.

Coach: Why?

Players: They were getting open.

Coach: How can you stop receivers from getting open or advancing far if they do catch passes?

Players: By covering them better.



Skill Practice (20 minutes)

1. Introduce, demonstrate, and explain how to cover receivers (see page 272).
2. Practice covering receivers.

Description

Divide the players into groups of three—each group has a quarterback, a receiver, and a defensive back. The groups will practice simultaneously; you call out the route that the receivers will run. Defenders practice the techniques that they have just learned. Rotate players after each play: defensive back to quarterback, quarterback to receiver, receiver to defensive back.

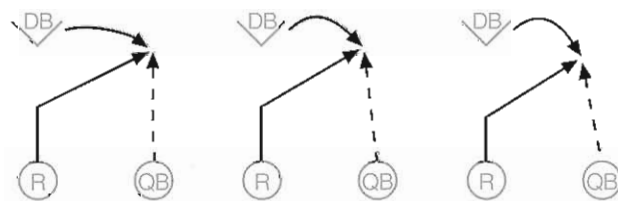

COACH'S cues



“Use a good drop step at the start.”

“Line up 7 or 8 yards away, on the receiver’s outside shoulder.”

“Look for the ball when the receiver looks for the ball.”

Game 2 (20 minutes)

Goal

To stop receivers from catching passes or advancing downfield if they do catch them.

Description

Play 6 v 6, with the offense calling its own plays. Start Team A on its own 20-yard line. Play a regular game, complete with punting. The defense plays in a 2-3-1 alignment. Give the defense one point for touching or knocking down an incomplete pass; one point for stopping a receiver from gaining additional yardage after a catch; and two points for an interception. The offense gets one point for each reception and two points for a touchdown.

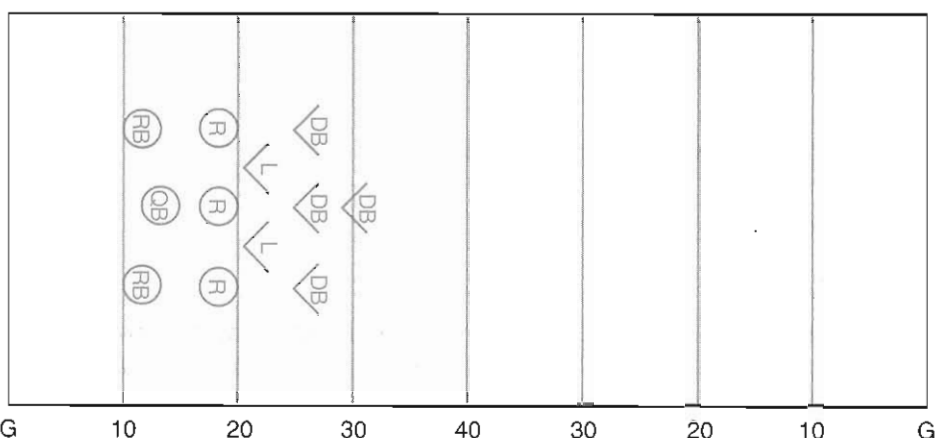

Instruct defensive backs to always keep the receivers in front of them—and never to turn their backs on the receivers.

Go over pass interference rules (see page 284).

Team Circle (5 minutes)

Key Idea: Respect

Gather the team and act out two examples of celebrating a good play or a win. One should be exaggerated and obviously inappropriate; the other should model the kind of celebrating you'd like to see from your team. "If you think the first example I showed you is the way to celebrate a good play, stand to my left. If you think the second is the best way to celebrate, stand to my right."

After all players have voted, ask them why they voted the way they did. "The second example is the kind of celebrating that shows respect for your opponents."

Wrap-Up

Make summary comments about practice and give reminders for the next game.



Week 7

PURPOSE

To learn a new pass pattern.

Equipment

- One football for every two players (youth-size: 10 1/4 to 10 1/2 in.)
- Flag belts for all players
- Grass field 40 yards by 80 yards

Warm-Up (10 minutes)

Have players jog one lap around the field and then pair up to play catch, running the pass patterns that they have learned. Assign two players to practice punting after they jog around the field.

Fitness Circle

(5 minutes)

Key Idea: Traffic safety

Gather the players together. "Walking, running, biking, or skating on sidewalks and paths is fun. But, be careful.

"Make sure you have your parent's/caregiver's permission. Make sure walkers, runners, skaters, and bikers are permitted to use these paths or roadways. Before using them, be certain you know the local rules and regulations like times of the day you may use them. Skate, bike, walk, or run at a pace that is at your level of ability. Yield to people who are walking. When on a path or sidewalk, do your exercise on the right side of the lane and pass on the left. Announce your intention to pass by stating, 'Passing on the left.' Learn and obey all traffic regulations. That means, if you like to bike or inline skate, you are to think of yourself as a car driver. Go in the direction of the traffic and stay on the right of the road. If you are a walker or jogger, face the traffic. Whatever you are doing, stay close to the edge of the road."

Activity: Trigger story

"You are hanging out with friends who like to inline skate. The leaders say they are going to go down to the bike path to 'blade.' You know there is a rule that no one is to inline skate on this trail. What would you do in this situation? Why? What will be the consequence of your action?"

Week 7

Game 1 (15 minutes)

Goal

To advance downfield using square-outs, slants, and curls.

Description

Play 6 v 6. The offense can use only three routes—square-outs, slants, and curls. Instruct the defense to play tight. Team A starts with the ball on its own 20-yard line. The defense plays a 2-3-1 defense. Play a regulation game, including punting, and award points this way: first downs equal two points, touchdowns merit six points.

Coach: How hard was it to advance downfield using only three patterns—especially when the defense knew which patterns to defend against?

Players: [varying responses]

Coach: How can we make it tougher on the defense, make it easier to move downfield?

Players: Learn another pass pattern.

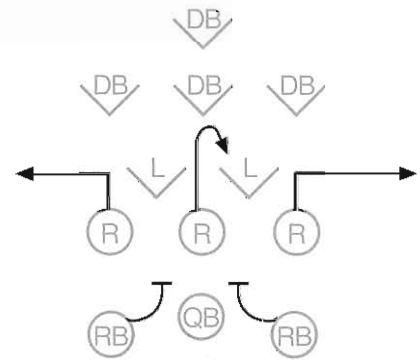

Skill Practice 1 (10 minutes)

1. Introduce, demonstrate, and explain how to run streak patterns (see page 247).
2. Practice running streak patterns.

Description

Pair players up and have them take turns running streaks. The receiver catches passes while running three streaks, then switches places with the quarterback, who runs three streaks. Keep switching back and forth in this manner.

COACH'S cues



“Sell the fake!”

“Look the ball into your hands!”

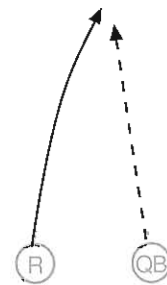



COACH'S points

 The best teams are the ones that execute the fundamentals.

 Go over the player-in-motion rule (see page 285).



Skill Practice 2 (20 minutes)

Description

Walk through the three pass plays and one run play that you have taught. Then run through the plays at full speed. Use a 2-3-1 defense.

Game 2 (10 minutes)

Goal

To advance downfield mixing running plays with passing plays.

Description

Play 6 v 6. Play a regulation game using the passing and running plays just practiced. The defense plays a 2-3-1 defense. Teams score two points each for first downs and for receptions by receivers running streak patterns, and six points for a touchdown.

Team Circle (5 minutes)

Key Idea: Respect

Gather the team into a group and choose two players to help demonstrate. One player is an official; the other is a quarterback. You are a receiver. Tell the quarterback to pass the ball over your head, out of bounds. Direct the "official" to blow a whistle or make a sound to stop play. Bring the ball back to the official. "What did I do when the whistle sounded?" Listen to their responses. Discuss stopping when they hear the whistle, bringing the ball to the official, and not arguing about the call. "You need to respect the officials and their decisions at all times. It also shows respect to the official when you thank them at the end of the game."

Wrap-Up

Make summary comments about practice and give reminders for the next game.

Week 8

Warm-Up (10 minutes)

Have players jog one lap around the field and then pair up to play catch, running the pass patterns that they have learned. Assign two players to practice punting after they jog around the field.

PURPOSE

To strengthen the offensive attack.

Equipment

- One football for every two players (youth-size: 10 1/4 to 10 1/2 in.)
- Flag belts for all players
- Grass field 40 yards by 80 yards

Fitness Circle (5 minutes)

Key Idea: Healthy habits

Gather the players together. "Someone your age usually drinks 15 ounces of soda pop each day, about 1 1/4 cans of soda. Your older friends drink almost 30 ounces, or 2 1/2 cans, of soda pop every day.

"It is hard for you not to like soft drinks. Soft drink companies sell to you. The ads say you will have fun and be cool.

"Soft drink manufacturers work hard to keep their prices low to encourage you to drink their beverages. Soft drinks cost about 2¢ to 8¢ per ounce, while milk and fruit juices sell for 3¢ to 8¢.

"Try your best to avoid liquid candy. They taste good, but they do nothing to build healthier bodies, make you run faster or jump higher, or do better at school."

Activity: Beverage store

Split the participants into five groups (2-3 participants each). Designate one group as milk (1), another as water (2), another as fruit juice (3), another as a fruit drink (4), and another as soda pop (5). Make sure each participant knows his group. Now tell the group members to scatter as far away from their groups as possible. When they are in this position, tell them to shut their eyes and turn around three times. Now tell them to keep their eyes closed and when you tell them to start, they should try to find their partners by shouting their beverage name. They may not look. The first team to find all (collect) their partners wins the game.

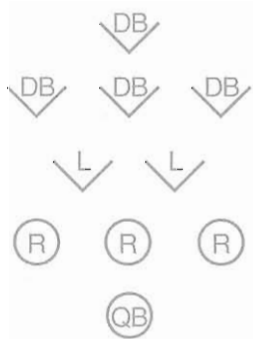

Game 1 (10 minutes)

Goal

To move downfield using only passing plays.

Description

Play 4 v 6 (rotate sideline players in after each play so a player only sits out one play at a time). The offense can only pass. Give two points for a first down and six for a touchdown. The defense can use double coverage on each receiver or choose to rush one or more players.

Coach: I know this was an uneven match-up—4 v 6. But besides that, why was it difficult to move downfield?

Players: Because the defense knew what was coming: passes. So they could overplay for the pass.

Coach: How can we make it tougher on the defense—make them more “honest”?

Players: By mixing in running plays.

Coach: Let’s learn two new running plays.

Skill Practice 1 (15 minutes)

1. Introduce, demonstrate, and explain how to execute run play #2—the 32 dive (see page 250).
2. Practice run play #2.

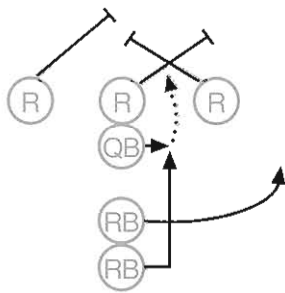

Description

Run two offenses of six players each on separate halves of the field. Set the players up in the correct positions and have them execute run play #2 several times. Have players rotate positions after several plays so that they can experience the play from different positions.

Skill Practice 2 (15 minutes)

1. Introduce, demonstrate, and explain how to execute run play #3—the 24 power (see page 251).
2. Practice run play #3.

Description

Run two offenses of six players each on separate halves of the field. Set the players up in the correct positions and have them execute run play #3 several times. Have players rotate positions after several plays so that they can experience the play from different positions.

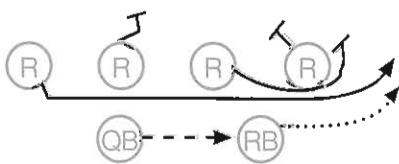

Week 8

Game 2 (15 minutes)

Goal

To move downfield using a mixture of running and passing plays.

Description

Play 6 v 6, using a mixture of the running and passing plays the players have learned. First downs are two points; touchdowns are six. The defense plays a 2-3-1 defense.



COACH'S
points

☞ Encourage a mix of plays to keep the defense guessing.

☞ Go over rules for line of scrimmage, clipping, and illegal use of hands (see pages 282 and 284).

Team Circle (5 minutes)

Key Idea: Responsibility

Gather the team. "What are some different ways you can move the ball down the field and score?" Listen to their responses. Provide the example of several players working together to move the ball and score as one choice. Give the example of one or two players working without many other teammates as the other choice. "Which of the two is the best example of teamwork? If you vote for the first group, stand to my left; if you vote for the second group, stand to my right. If everyone makes good teamwork their responsibility, we can all work together to be successful. When you're responsible to your team, you become a better player."

Wrap-Up

Make summary comments about practice and give reminders for the next game.



Week 9

PURPOSE

To play effective defense.

Equipment

- One football for every two players (youth-size: 10 1/4 to 10 1/2 in.)
- Flag belts for all players
- Grass field 40 yards by 80 yards
- Food Guide Pyramid

Warm-Up (10 minutes)

Have players jog one lap around the field and then pair up to play catch, running the pass patterns that they have learned. Assign two players to practice punting after they jog around the field.

Fitness Circle (5 minutes)

Key Idea: Healthy habits

Materials: Copy of the Food Guide Pyramid

Gather the players together. "Food is good for you. It helps you grow strong and tall. You need to eat well to play a sport such as football. To make sure the food you eat will help you be at your best, use the Food Guide Pyramid."

Activity: Food Guide Pyramid

Hold the Food Guide Pyramid in front of you and explain the Guide to the participants. "Each day you need to eat these things:

- Six to eleven servings of bread, cereal, rice, and pasta.
- Three to five servings from the vegetable group.
- Two to four servings from the fruit group.
- Two to three servings from the milk, yogurt, and cheese group.
- Two to three servings from the meat, poultry, fish, dried beans, eggs, and nuts group.
- Use fats, oils, and sweets carefully.

Refer to the Food Guide Pyramid on page 301.

Week 9

Game 1 (10 minutes)

Goal

To stop the offense from gaining first downs.

Description

Play 6 v 5, with the five defenders covering the receivers (no one rushes the quarterback). Give two points to the offense for a first down and two points to the defense for stopping a first down from being gained.

Coach: Aside from the fact that the defense was short one player, why was it tough on the defense?

Players: The quarterback had all day to find a receiver and throw.

Coach: How can we make it harder on the quarterback?

Players: Put a rush on.



Skill Practice 1 (15 minutes)

1. Introduce, demonstrate, and explain the swim technique for rushing the passer (see page 271).
2. Practice rushing the quarterback using the swim technique.

Description

Put players into groups of three, with each group having a quarterback, a blocker, and a rusher. Have the blocker block for the quarterback; the rusher uses the swim technique to rush the quarterback. Rotate players after each play: rusher goes to quarterback, quarterback to blocker, blocker to rusher.



COACH'S cues



"Bring your arm up!"

"Push off!"

Skill Practice 2 (10 minutes)

1. Introduce, demonstrate, and explain the spin technique for rushing (see page 272).
2. Practice rushing the quarterback using the spin technique.

Description

Repeat skill practice 1 using the spin technique.



"Make contact!"
"Spin!"

Game 2 (15 minutes)

Goal

To effectively rush the quarterback.

Description

Play 6 v 6. Team A starts at its own 20-yard line and runs six plays (regardless of whether they gain a first down or not). Then Team B goes on offense for six plays, beginning at its own 20-yard line. The offense can only pass. The defense plays a 2-3-1 defense and can employ one or two rushers. Give the defense one point for each incomplete pass, two points for each rush technique performed correctly (swim or spin), and three points for each "sack"—when a defender pulls the quarterback's flag before the quarterback passes the ball.



☞ The best way to take the offense out of its rhythm is to effectively rush the passer.

☞ Go over the defensive holding rule (see page 284).

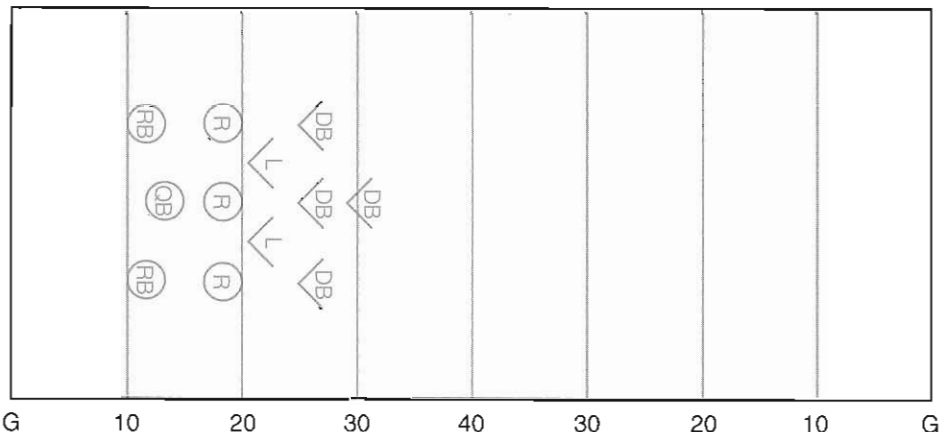

Week 9

Team Circle (5 minutes)

Key Idea: Caring

Gather the team into a group and choose three players to demonstrate. These three will move down the field, playing catch while running pass patterns. Have them go about 20 yards down the field and then back to the group. Set up another group to do the same activity. Rotate the other players one at a time into the two groups until they all get a turn. Bring the team back together to discuss. "What was happening every time a new person came into the passing group?" Listen to their responses. Discuss many players getting playing time. "When we share playing time, it shows that you care about your teammates. Players who care about each other want the whole team to get a chance to play. That way everyone can contribute to the team. It is more important that everyone get a chance to learn and play than it is to only play our best players so we have the best chance of winning."

Wrap-Up

Make summary comments about practice and give reminders for the next game.



Week 10

PURPOSE

To strengthen the offensive attack.

Equipment

- One football for every two players (youth-size: 10 1/4 to 10 1/2 in.)
- Flag belts for all players
- Grass field 40 yards by 80 yards

Warm-Up (10 minutes)

Have players jog one lap around the field and then break into groups of three to run (and defend against) pass plays. Have players rotate between quarterback, receiver, and defender within their group. Assign two or three players to practice punting after they jog around the field.

Fitness Circle (5 minutes)

Key Idea: Healthy habits

Gather the players together. "Cigarette smoking causes more deaths and disease than any other single thing—more than improper food, lack of exercise, murders, or drugs. Cigarette smoking causes cancer, heart and lung diseases, pregnancy problems, and early death. Secondhand smoke, the smoke you inhale when you live with or sit next to smokers, can cause problems as well.

"Most people who smoke when they are adults started when they were your age. In fact, the younger a person starts smoking, the more likely he or she will be a heavy smoker as an adult."

Activity: How many?

"Answer these questions:

1. How many of you think that smoking hurts football players' performance? Why do you think so?
2. How many of you think that smokers have rights, too? Why do you think so?
3. How many of you think that you can ask another person not to smoke? Why do you think so?
4. How many of you think it is not good for coaches, teachers, and parents to smoke? Why do you think so?
5. How many of you think you will smoke as adults? Why do you think so?"

Week 10

Game 1 (15 minutes)

Goal

To gain maximum yardage on punt returns.

Description

Play 6 v 4, with the six on the punting team (rotate players in on each play so that no one is out for more than one play). Team A punts three times from its 20-yard line; Team B receives and returns the punts. Then switch defense and offense; Team A returns three punts. Keep rotating in this manner. Give one point to the receiving team for every 10 yards gained on the return.

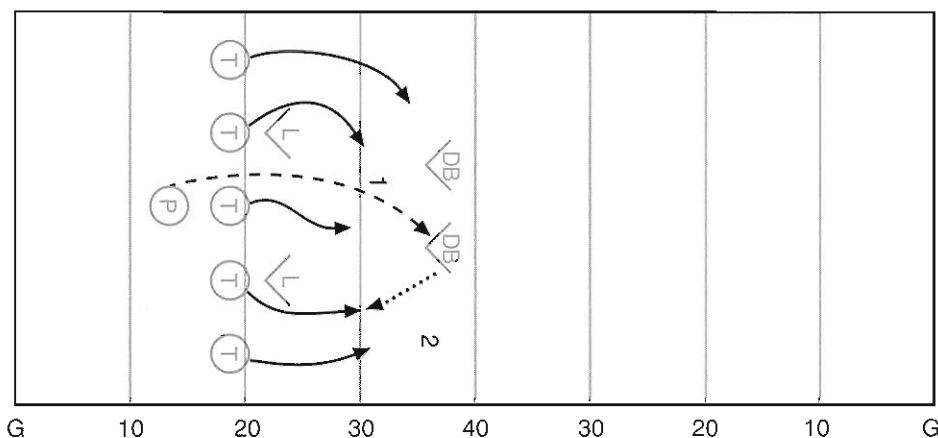

Coach: What was the object of the game?

Players: To return punts as far as we could.

Coach: Why was it hard to return punts very far?

Players: Because we were outnumbered. We had no blocking.

Coach: Let's learn an effective punt return formation—with six players.



Skill Practice (20 minutes)

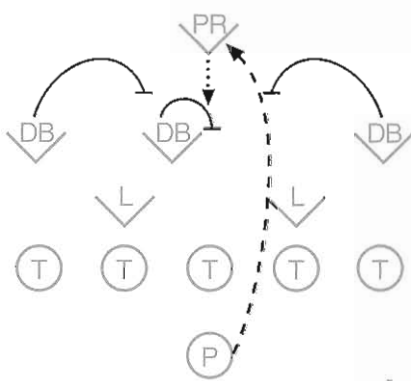

1. Introduce, demonstrate, and explain how to use a 2-3-1 punt return formation (see page 266).
2. Practice returning punts.

Description

Play 6 v 6. Team A punts six times to Team B, who is in a 2-3-1 formation. Team B returns the punts as far as possible. Then switch and have Team A return six punts. Put different receivers back to receive each punt.

COACH'S cues



- “Look the ball into your hands!”
- “V formation!”
- “Follow your blocking!”

COACH'S points

☞ Players should follow their blockers when returning punts.

☞ Go over the unnecessary roughness rule (see page 285).

Game 2 (20 minutes)

Goal

To gain maximum yardage on punt returns.

Description

Repeat game 1, except play 6 v 6.

Team Circle (5 minutes)

Key Idea: Caring

Gather the team. "Let's imagine we're playing in a game and one of your teammates passes to you. The pass is over your head. Pretend you say, 'What a terrible pass! Get out of here until you learn how to play flag football!' How would you change your comment to sound more positive and make the person feel better?" Listen to their responses. "It is important to make positive comments and not get upset when your teammates make mistakes. This shows you care about your teammates."

Wrap-Up

Make summary comments about practice and give reminders for the next game.



Week 11

PURPOSE

To play effective defense.

Equipment

- One football for every two players (youth-size: 10 1/4 to 10 1/2 in.)
- Flag belts for all players
- Grass field 40 yards by 80 yards

Warm-Up (10 minutes)

Have players jog one lap around the field and then break into groups of three to run (and defend against) pass plays. Have players rotate between quarterback, receiver, and defender within their groups. Assign two or three players to practice punting after they jog around the field.

Fitness Circle (5 minutes)

Key Idea: Flexibility

Gather children into a circle sitting down with their legs stretched in front of them. "Think of stretching a rubber band as far as you can. What happens if you stretch the band too far?" Listen to their responses. "That's right. It breaks. Muscles work in sort of the same way. Stretching your muscles too far can tear and injure them. But it's important to stretch your muscles for them to be flexible. Everyone reach forward and try to touch your toes, but stretch only until you feel a slight pulling in your leg muscle—make sure it doesn't hurt." Tell them to hold the stretch for 10 counts without bouncing. "Stretching your muscles is important to keep them flexible, but you shouldn't feel pain. The main muscles to stretch for football are the front of your thighs (quadriceps), the back of your thighs (hamstrings), and the back of your lower legs (calves)." Demonstrate stretching each muscle group.

Game 1 (15 minutes)

Goal

To limit punt return yardage.

Description

Play 6 v 6. Team A punts to Team B from Team A's 20-yard line. Team B returns the punt as far as possible. Then Team B punts to Team A from Team B's 20-yard line, and Team A returns the punt as far as possible. Whichever team limited the return team to fewer yards wins a point. Keep repeating this pattern, playing out as many points as time allows.

Week 11

Coach: How hard was it to limit the return team's yards?

Players: [various answers]

Coach: What's the best way to cover punts?

Players: Everyone stays in their lanes.



Skill Practice (20 minutes)

1. Introduce, demonstrate, and explain how to cover punts (see page 266).
2. Practice covering punts.

Description

Play 6 v 6. Team A punts six times to Team B, who is in a 2-3-1 formation. Team B returns the punts as far as possible; Team A runs its lanes and pulls the ball carrier's flag as quickly as possible. Then switch and have Team A return six punts. Put different receivers back to receive each punt.

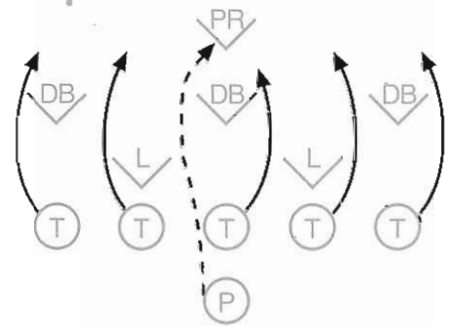

COACH'S cues



"Run your lanes!"

"Let the ball carrier come to you!"

Game 2 (20 minutes)

Goal

To gain yardage on offense and limit punt returns on defense.

Description

Play 6 v 6. Team A starts on its 20-yard line and runs six plays (regardless of whether they make a first down or not). The defense plays a 2-3-1 defense. During this time give two points for each first down and six points for a touchdown. On the seventh play, Team A returns to its 20-yard line and punts to Team B. Give Team A three points for holding Team B to a return of 5 yards or less; two points for a return of 6 to 10 yards; and no points for returns greater than 10 yards. Then flip-flop and have Team B on offense for its seven plays.

COACH'S points



☞ The players in the outside lanes can't let ball carriers past them on the outside.

☞ Go over the fair catch interference rule (see page 285).



Team Circle (5 minutes)

Key Idea: Responsibility

Gather the team into a group. Choose one player to demonstrate with you. Let the player know you'll be passing the ball and that he or she should pretend to be in position to score a touchdown. Make a bad pass to the player. Identify that the bad pass was your mistake. "Raise your hand if you think it's a part of learning when you make a bad pass." Give them time to raise their hands. "Now raise your hand if you think a bad pass means you are not a good player." Give them time to raise their hands. "Everyone makes mistakes, and when you make one it does not mean you're a bad player. It does mean you might need to practice more."

That is how you can be responsible to your team.

Wrap-Up

Make summary comments about practice and give reminders for the next game.

Week 12

Warm-Up (10 minutes)

Have players jog one lap around the field and then break into groups of three to run (and defend against) pass plays. Have players rotate between quarterback, receiver, and defender within their groups. Assign two or three players to practice punting after they jog around the field.

Fitness Circle (5 minutes)

Key Idea: Safety

Gather children into a group. Choose one player to act out being injured (limping) and have a second player get a coach to report the injury. "What did you see happening?" Listen to their responses. "When you get injured, it will probably look like what was acted out. If it hurts, you should stop and let me know right away. Don't pretend it doesn't hurt. Most times injuries are not bad, but sometimes they can be serious. If you get hurt even a little, I need to come over and check your injury. If you see a player who looks hurt or in pain or if you saw her get injured, let me know. Telling me if you're hurt helps me keep you safe during games and practices."

Game 1 (15 minutes)

Goal

To advance downfield using a mixture of running and passing plays.

Description

Play 6 v 6. The defense plays a 2-3-1 defense. Give two points for each first down, six points for a score, and three points each for an interception and a "sack" (quarterback's flag pulled behind the line of scrimmage before he or she can pass).

Coach: What's the key to a good offense?

Players: Good execution, good mixture of plays.

PURPOSE

To strengthen the offensive attack.

Equipment

- One football for every two players (youth-size: 10 1/4 to 10 1/2 in.)
- Flag belts for all players
- Grass field 40 yards by 80 yards



Skill Practice (15 minutes)

Description

Practice any of the running or passing plays that you feel the team most needs to work on, based on their play in game 1.

Game 2 (25 minutes)

Goal

To advance downfield using a mixture of running and passing plays.

Description

Repeat game 1.

**COACH'S
points**

☞ Teach players to come back to the quarterback when they have run their pattern and the quarterback is under pressure.

☞ Go over handoff rules (see page 282).



Team Circle (5 minutes)

Key Idea: Respect

Pair off the players. "Each of you tell your partner two or three ways you saw other players show respect this season. I'll give you two minutes." After two minutes, bring the players back together again. "Tell us what some of the examples were." Listen to examples and discuss. "It's important to notice respect being practiced and to talk about what we saw. All season we have been working on both flag football skills and being good teammates. Improving both of those areas tells me you have respect for yourselves and your teammates."

Wrap-Up

Make summary comments about practice and give reminders about the final game.